

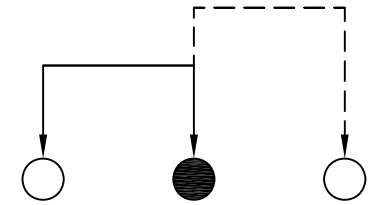

CAD FILE:

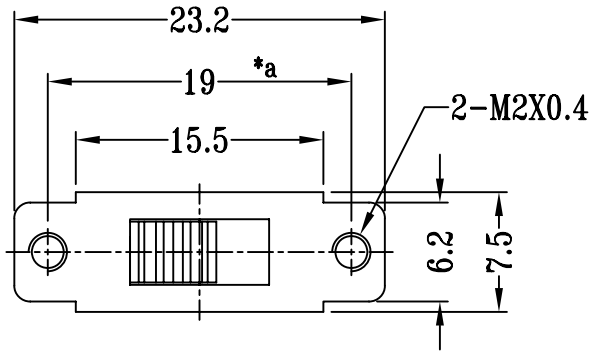

SCHEMATIC (NON-SHORTING)

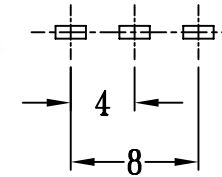
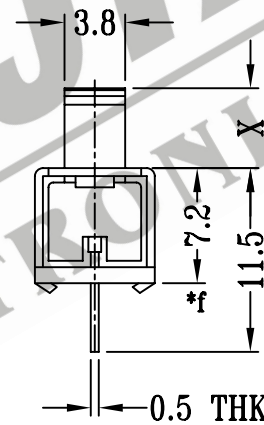
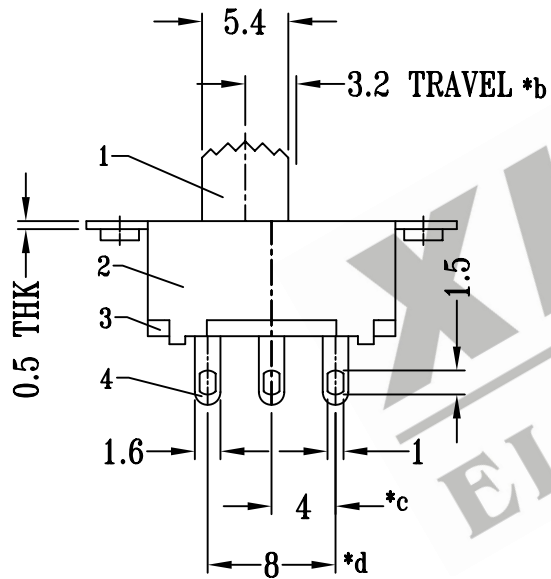

P.C.B LAYOUT

注:带"\*"表示关键尺寸(6个)

NO.	PARTS	MATERIALS	Q'TY	FINISH	TOLERANCE UNLESS SPECIFIED	SHENZHEN XIEJIA ELECTRONICS CO.,LTD.					
8					WITHIN: 1.5±0.1mm OVER : 1.5±0.2mm	ISSUE		DATE		DESCRIPTIONS OF REVISION	APPD.
7						TITLE : VERTICAL SLIDE SWITCH		UNIT : mm	DRWG NO.: XJ-DR-SS12F29-00		
6	CONTACT CLIP	COPPER STRIP	1	Ag PLATED	MODEL: SS-12F29		SCALE: 2 : 1	DWN.	ZHOUYU	2004-8-23	
5	SPRING	STEEL WIRE	1	TEMPER	ALL MATERIALS MUST BE COMPLIANT TO ROHS			CHK'D	FANGYING	2004-8-23	
4	TERMINAL	BRASS STRIP	3	Ag PLATED OVER Ni PLATED				APPD.	KANGXINAN	2004-8-23	
3	BASE	PHENOLIC RESIN	1	BLACK							
2	FRAME	STEEL STRIP	1	BLACK							
1	KNOB	POM	1	BLACK							